

Serie Light

SR325LI/SR325LE

Nylon Cable Chain with openable frames

Inner height (D) 25 mm

Single link construction with central large anti-friction pivot, for high torsion and tensile resistance.

Frames openable from inner radius (SR325LI) or from outer radius (SR325LE). Vertical separators available. Used with guide channels, this chain is particularly suitable for long distance travel.

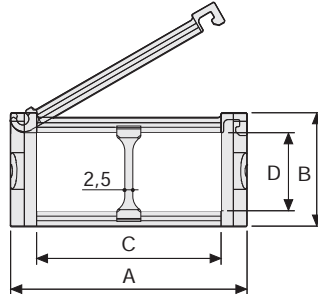

Separator

- Unassembled	Part.no S325L
- Assembled	Part.no S325LMC

Technical characteristics when self-supported

Speed	10 m/s
Acceleration	50 m/s ²

For higher requirements please consult our technical dept.

A	B	C	D	R	Weight/m	Chain
mm	mm	mm	mm	mm	kg	Part Number
57	38	40	25	050-060-075-100-125-150	0,90	SR325LI(LE)040□□□*
77	38	60	25	050-060-075-100-125-150	0,95	SR325LI(LE)060□□□*
93	38	76	25	050-060-075-100-125-150	1,05	SR325LI(LE)076□□□*
120	38	103	25	050-060-075-100-125-150	1,15	SR325LI(LE)103□□□*

*Complete the code by inserting the value of the radius (R): Ex. SR325LI040 □ □ □ □

For sliding applications, technical data can slightly change according to frequency, added weight and environment.

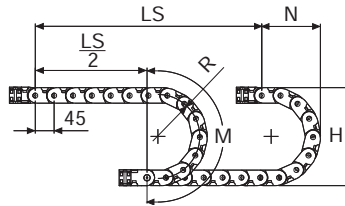

R	H	N	M	N1	M1
mm	mm	mm	mm	mm	mm
050	138	115	250	145	300
060	158	125	280	155	335
075	188	140	325	185	420
100	238	165	405	275	635
125	288	190	485	360	855
150	338	215	565	445	1075

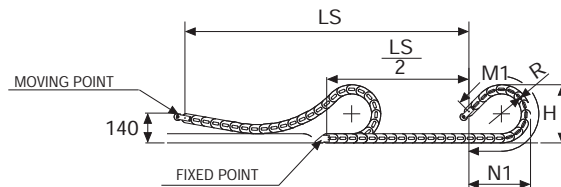

Length of chain (L)
 Half travel distance ($\frac{LS}{2}$)
 plus length of curve (M) or (M1)

$$L = \frac{LS}{2} + M \text{ o } M1$$

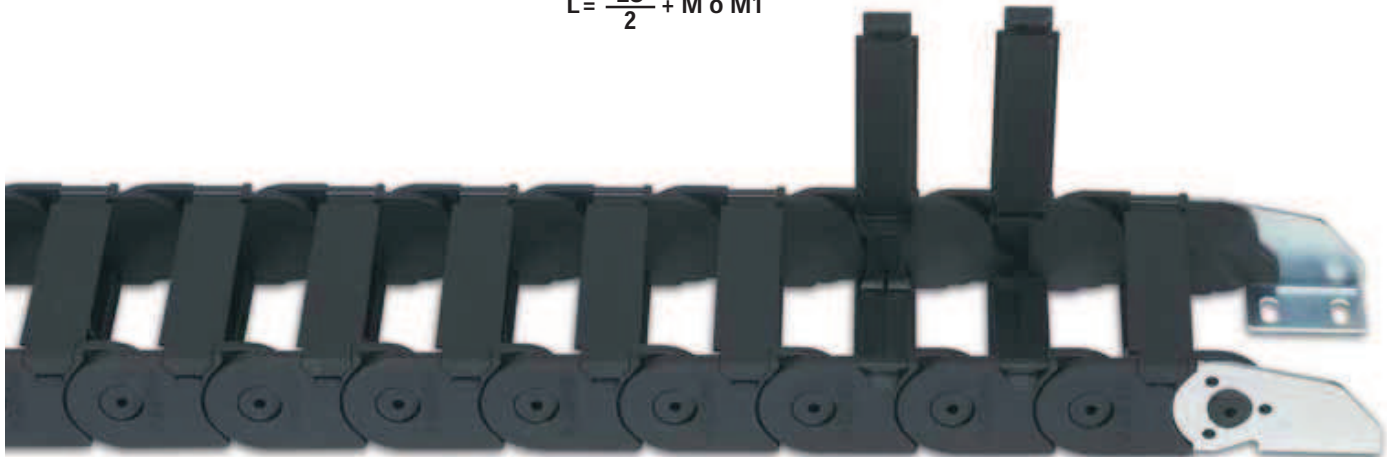

Self-Supporting Capacity Diagram

The maximum length of the self-supporting capacity ($\frac{LS}{2}$) in relationship to the weight of the cables and hoses contained per linear metre.

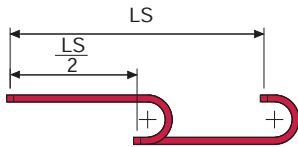
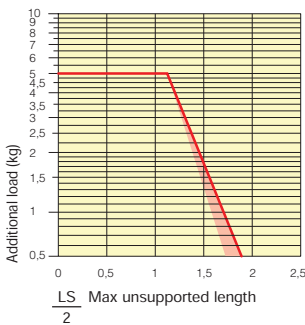

The red marking in the diagram area considers the difference of weight between various widths of chain.

For applications with $\frac{LS}{2}$ and weights not included in the area of the diagram showing self-supporting capacity, verify the possible use of support rollers (see page 30).

End Brackets

The end brackets set allows the two ends of the chain to be attached to the equipment. Set complete with tiewrap clamps available on request.

Nylon Type

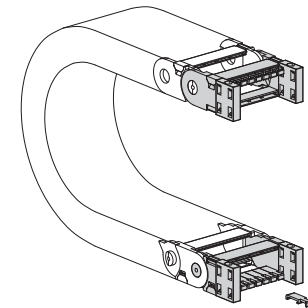
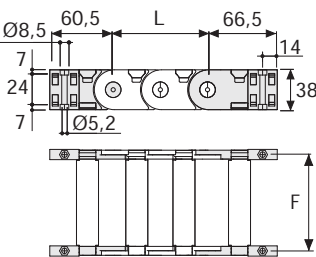

Fig. A Chain fixed outside/inside the radius. (Fig A)



Chain Type	F mm
SR325L...040	51
SR325L...060	71
SR325L...076	87
SR325L...103	114

Nylon Type Part Numbers

Complete Set Assembled	End Brackets
Type	Set
SR325L...	AN325L□□□*KM

Complete Set Unassembled	End Brackets
Type	Set
SR325L...	AN325L□□□*K

Tiewrap Clamp	Part Number
Assembled	CFC325L □□□ *KM
Unassembled	CFC325L □□□ *K

* Complete the code by inserting the value of the quote C.

Bright Zinc Plated Steel Type*

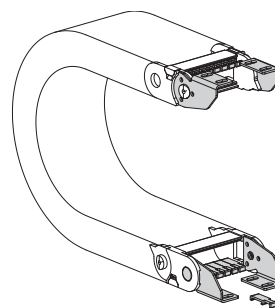
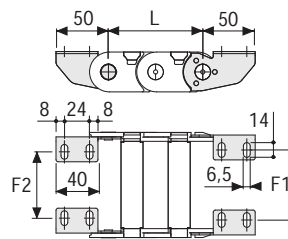

Fig. B Chain fixed outside the radius. (Fig B) See end brackets mounting variations page 31.



Chain Type	F2 mm	F1 mm
SR325L...040	20	23,5
SR325L...060	40	43,5
SR325L...076	56	59,5
SR325L...103	83	86,5

Bright Zinc Plated Steel Type Part Numbers

Complete Set Assembled	End Brackets
Type	Set
SR325L...	A325LK**

*Available on request in stainless steel
**See end brackets mounting variations page 31.

Serie Light

SR325LI SR325LE

Nylon Cable Chain with openable frames

Separation System

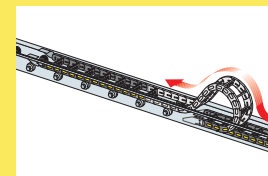
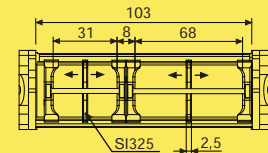
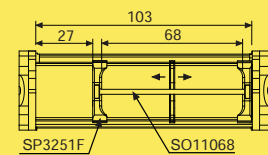
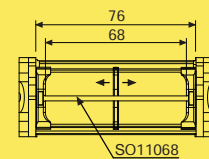
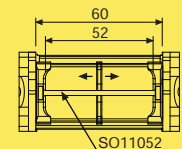
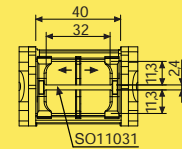

Suitable to long travel distance. To choose the guide channel see page 54

For further information please consult Brevetti Stendalto's Technical Office

