

# Serie Heavy

# SR306SI/SR306SE

## Nylon Cable Chain with openable frames

### Inner height (D) 37 mm

Strong double share Sideband & Frame construction with large anti-friction triple-pin. Frames openable from inner radius (..SI) and outer radius (..SE).

As standard the chain comes with frames every second link, on request with frames every link.

Vertical and horizontal modular separator system is available.

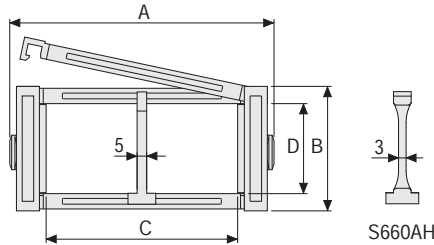

### Separator

- Unassembled Part.no S660A
- Assembled Part.no S660AMC

### Strong-hold separator

for C > 200 mm

- Unassembled Part.no S660AH
- Assembled Part.no S660AHMC

### Pin

Part.no PG307

### Technical characteristics when self-supported

Speed	8 m/s
Acceleration	40 m/s <sup>2</sup>

For higher requirements please consult our technical dept.

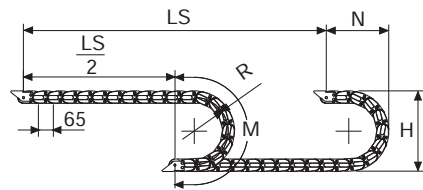

Length of chain (L)

Half travel distance ( $\frac{LS}{2}$ )

plus length of curve (M)

$$L = \frac{LS}{2} + M$$

R	H	N	M
mm	mm	mm	mm
075	205	170	370
107	269	205	470
150	355	245	605
200	455	295	760
250	555	345	920
300	655	395	1075

A	B	C	D	R	Weight/m	Chain
mm	mm	mm	mm	mm	kg	Part Number
79	55	43	37	075-107-150-200-250-300	1,61	SR306SI(SE)043□□□*
90	55	54	37	075-107-150-200-250-300	1,61	SR306SI(SE)054□□□*
104	55	68	37	075-107-150-200-250-300	1,68	SR306SI(SE)068□□□*
110	55	74	37	075-107-150-200-250-300	1,70	SR306SI(SE)074□□□*
124	55	88	37	075-107-150-200-250-300	1,74	SR306SI(SE)088□□□*
129	55	93	37	075-107-150-200-250-300	1,74	SR306SI(SE)093□□□*
136	55	100	37	075-107-150-200-250-300	1,76	SR306SI(SE)100□□□*
146	55	110	37	075-107-150-200-250-300	1,77	SR306SI(SE)110□□□*
154	55	118	37	075-107-150-200-250-300	1,82	SR306SI(SE)118□□□*
165	55	129	37	075-107-150-200-250-300	1,85	SR306SI(SE)129□□□*
179	55	143	37	075-107-150-200-250-300	1,89	SR306SI(SE)143□□□*
204	55	168	37	075-107-150-200-250-300	1,96	SR306SI(SE)168□□□*
229	55	193	37	075-107-150-200-250-300	2,04	SR306SI(SE)193□□□*
240	55	204	37	075-107-150-200-250-300	2,07	SR306SI(SE)204□□□*
254	55	218	37	075-107-150-200-250-300	2,11	SR306SI(SE)218□□□*
281	55	245	37	075-107-150-200-250-300	2,19	SR306SI(SE)245□□□*
290	55	254	37	075-107-150-200-250-300	2,22	SR306SI(SE)254□□□*
341	55	305	37	075-107-150-200-250-300	2,34	SR306SI(SE)305□□□*
363	55	327	37	075-107-150-200-250-300	2,41	SR306SI(SE)327□□□*
391	55	355	37	075-107-150-200-250-300	2,49	SR306SI(SE)355□□□*

\*Complete the code by inserting the value of the radius (R): Ex. SR306SI(SE)110 □ □ □ □  
Chain equipped with nylon frame every pitch: complete the code by inserting the letter D.  
Ex. SR306SI(SE)110150 □



### Self-Supporting Capacity Diagram

The maximum length of the self-supporting capacity ( $\frac{LS}{2}$ ) in relationship to the weight of the cables and hoses contained per linear metre.

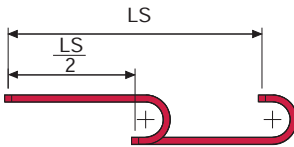
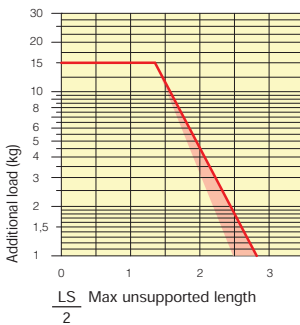

The red marking in the diagram area considers the difference of weight between various widths of chains assembled with nylon frames every second pitch.

For applications with  $\frac{LS}{2}$  and weights not included in the area of the diagram showing self-supporting capacity, verify the possible use of support rollers (see page 30).

### End Brackets

The end brackets set allows the two ends of the chain to be attached to the equipment.

#### Nylon Type

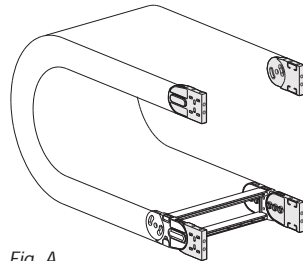

Fig. A  
The chain can be fixed frontally, inner or outer radius. (Fig A)

#### Bright Zinc Plated Steel Type\*

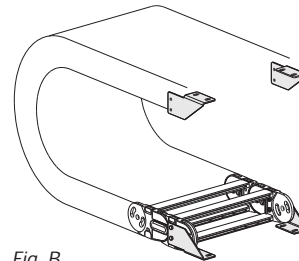
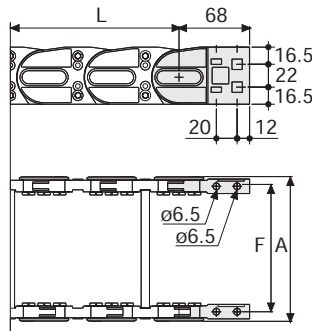

Fig. B  
Chain fixed outside the radius. (Fig B)  
See end brackets mounting variations page 31.



Chain Type	F mm
SR306SI(SE)043	61
SR306SI(SE)054	72
SR306SI(SE)068	86
SR306SI(SE)074	92
SR306SI(SE)088	106
SR306SI(SE)093	111
SR306SI(SE)100	118
SR306SI(SE)110	128
SR306SI(SE)118	136
SR306SI(SE)129	147
SR306SI(SE)143	161
SR306SI(SE)168	186
SR306SI(SE)193	211
SR306SI(SE)204	222
SR306SI(SE)218	236
SR306SI(SE)245	263
SR306SI(SE)254	272
SR306SI(SE)305	323
SR306SI(SE)327	345
SR306SI(SE)355	373

#### Nylon Type Part Numbers

Complete Set Assembled Chain Type	End Brackets Set
SR306SI(SE)...	AN306KM

Complete Set Unassembled Chain Type	End Brackets Set
SR306SI(SE)...	AN306K

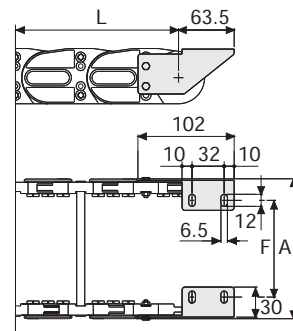

Chain Type	F mm
SR306SI(SE)043	36
SR306SI(SE)054	47
SR306SI(SE)068	61
SR306SI(SE)074	67
SR306SI(SE)088	81
SR306SI(SE)093	86
SR306SI(SE)100	93
SR306SI(SE)110	103
SR306SI(SE)118	111
SR306SI(SE)129	122
SR306SI(SE)143	136
SR306SI(SE)168	161
SR306SI(SE)193	186
SR306SI(SE)204	197
SR306SI(SE)218	211
SR306SI(SE)245	238
SR306SI(SE)254	247
SR306SI(SE)305	298
SR306SI(SE)327	320
SR306SI(SE)355	348

#### Bright Zinc Plated Steel Type Part Numbers

Complete Set Assembled Chain Type	End Brackets Set
SR306SI(SE)...	A306SKM □ **

Complete Set Unassembled Chain Type	End Brackets Set
SR306SI(SE)...	A306SK □ **

\*Available on request in stainless steel  
\*\* 1=Pos.1; 2=Pos.2; 3=Pos.3  
See end brackets mounting variations page 31.

### Serie Heavy

## SR306SI SR306SE

Nylon Cable Chain with openable frames

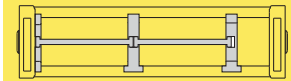

Separation System  
To choose the separators see page. 174

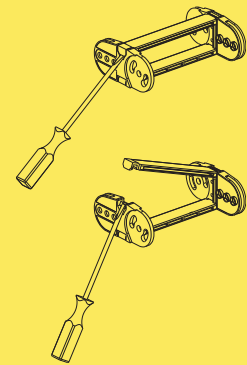

How to open the cover.

#### Protection version



Protection version see page 124

For further information please consult Brevetti Stendaito's Technical Office

