

Serie Heavy

SR306F

Nylon Cable Chain

with un-screwable split cross pieces with holes

Strong double share Sideband & Frame construction with large anti-friction triple-pin. Un-screwable nylon split cross pieces with different hole combinations. As standard the chain comes with frames every second link, on request with frames every link.

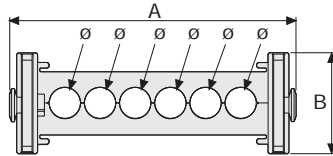

Pin
Part.no PG307

Technical characteristics when self-supported

Speed	8 m/s
Acceleration	40 m/s ²

For higher requirements please consult our technical dept.

A	B	N.	Ø	R	Weight/m	Chain
mm	mm	holes	mm	mm	kg	Part Number
89	55	2	22	075-107-150-200-250-300	1,80	SR306001 □*
155	55	6	17	075-107-150-200-250-300	2,05	SR306002 □*
193	55	6+2	17+20	075-107-150-200-250-300	2,30	SR306003 □*
214	55	6	25	075-107-150-200-250-300	2,55	SR306004 □*
113	55	3	23	075-107-150-200-250-300	1,95	SR306005 □*

*Complete the code by inserting the value of the radius (R): Ex. SR306002 □

Where: 1=075; 2=107; 3=150; 4=200; 5=250; 6=300

Chain equipped with nylon frame every pitch: complete the code by inserting the letter D.

Ex. SR3060021 □

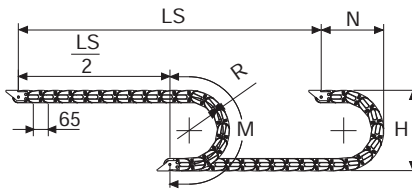

R	H	N	M
mm	mm	mm	mm
075	205	170	370
107	269	205	470
150	355	245	605
200	455	295	760
250	555	345	920
300	655	395	1075

Length of chain (L)

Half travel distance ($\frac{LS}{2}$)
plus length of curve (M)

$$L = \frac{LS}{2} + M$$



Self-Supporting Capacity Diagram

The maximum length of the self-supporting capacity ($\frac{LS}{2}$) in relationship to the weight of the cables and hoses contained per linear metre.

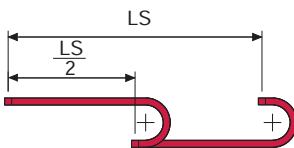
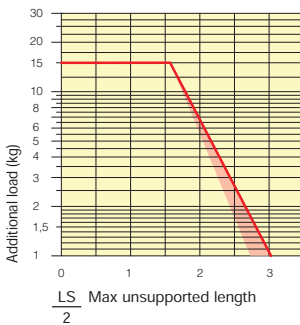

The red marking in the diagram area considers the difference of weight between various widths of chains assembled with nylon cross pieces every second pitch.

For applications with $\frac{LS}{2}$ and weights not included in the area of the diagram showing self-supporting capacity, verify the possible use of support rollers (see page 30).

End Brackets

The end brackets set allows the two ends of the chain to be attached to the equipment.

Nylon Type

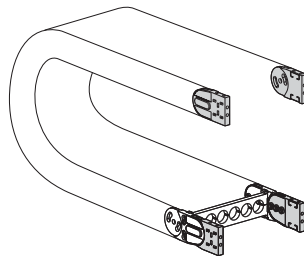

Fig. A
The chain can be fixed frontally, inner or outer radius. (Fig A)

Bright Zinc Plated Steel Type*

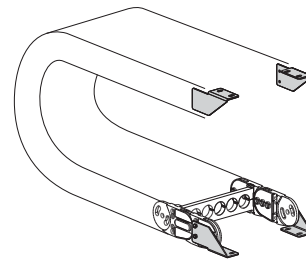
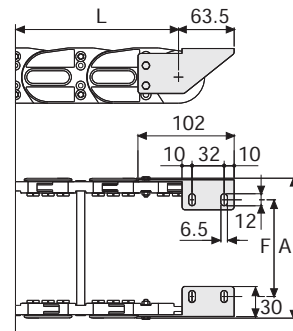
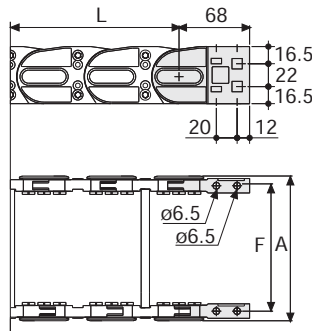

Fig. B
Chain fixed outside the radius. (Fig B)
See end brackets mounting variations page 31.



Chain Type	F mm
SR306001	70
SR306002	136
SR306003	174
SR306004	195
SR306005	94

Chain Type	F mm
SR306001	45
SR306002	111
SR306003	149
SR306004	170
SR306005	69

Nylon Type Part Numbers

Complete Set Assembled	
Chain	End Brackets
Type	Set
SR30600...	AN306KM

Complete Set Unassembled	
Chain	End Brackets
Type	Set
SR30600...	AN306K

Bright Zinc Plated Steel Type Part Numbers

Complete Set Assembled	
Chain	End Brackets
Type	Set
SR30600...	A306KM □**

Complete Set Unassembled	
Chain	End Brackets
Type	Set
SR30600...	A306K □**

*Available on request in stainless steel
** 1=Pos.1; 2=Pos.2; 3=Pos.3
See end brackets mounting variations page 31.

Serie Heavy

SR306F

Nylon Cable Chain with un-screwable nylon split cross pieces with holes

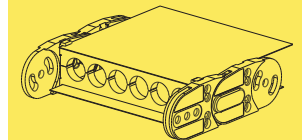

Steel laminar cover.

Special tool to remove the connecting pivots:
Part Number PZ036.



For further information please consult Brevetti Stendaito's Technical Office

