

Serie Protection

SR309C Nylon Protection Cable Chain with openable covers

Inner height (D) 72 mm

Strong double share Sideband & Frame construction with large anti-friction triple-pin.
Covers are openable from outer radius
Vertical and horizontal separator systems are available.

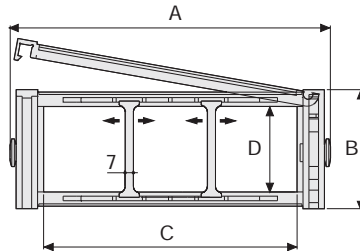

Separator

- Unassembled	Part.no S309PO
- Assembled	Part.no S309POMC

Pin

Part.no PG309

Technical characteristics when self-supported

Speed	8 m/s
Acceleration	40 m/s ²

For higher requirements please consult our technical dept.

A	B	C	D	R	Weight/m	Chain
mm	mm	mm	mm	mm	kg	Part Number
256	100	200	72	200-250-300-350-400-500	5,7	SR309C200□□□*
356	100	300	72	200-250-300-350-400-500	6,8	SR309C300□□□*
456	100	400	72	200-250-300-350-400-500	7,9	SR309C400□□□*

*Complete the code by inserting the value of the radius (R): Ex. SR309C200 □□□□

3

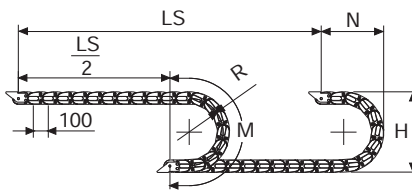

R	H	N	M
mm	mm	mm	mm
200	500	350	830
250	600	400	985
300	700	455	1145
350	800	500	1300
400	900	555	1460
500	1100	650	1770

Length of chain (L)

Half travel distance ($\frac{LS}{2}$)
plus length of curve (M)

$$L = \frac{LS}{2} + M$$



Self-Supporting Capacity Diagram

The maximum length of the self-supporting capacity ($\frac{LS}{2}$) in relationship to the weight of the cables and hoses contained per linear metre.

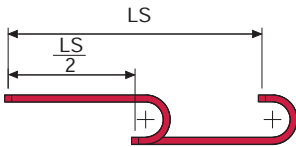
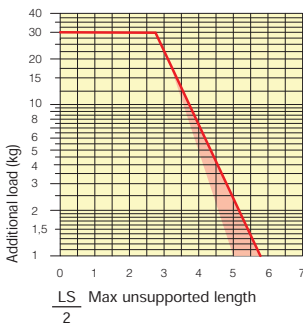

The red marking in the diagram area considers the difference of weight between various widths of chain.

For applications with $\frac{LS}{2}$ and weights not included in the area of the diagram showing self-supporting capacity, verify the possible use of support rollers (see page 30).

End Brackets

The end brackets set allows the two ends of the chain to be attached to the equipment.

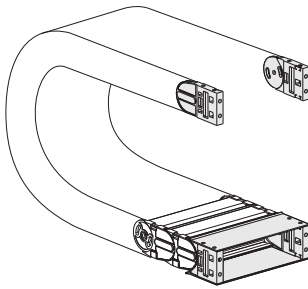
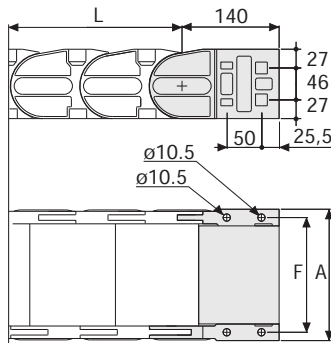

Fig. A
The chain can be fixed frontally, inner or outer radius. (Fig A)



Chain Type	F mm
SR309C200	229
SR309C300	329
SR309C400	429

Nylon Type Part Numbers

Complete Set Assembled	
Chain Type	End Brackets Set
SR309C200	AN309C200KM
SR309C300	AN309C300KM
SR309C400	AN309C400KM

Complete Set Unassembled	
Chain Type	End Brackets Set
SR309C200	AN309C200K
SR309C300	AN309C300K
SR309C400	AN309C400K

Serie Protection

SR309C

Nylon Protection Cable Chain
with openable covers

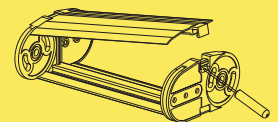
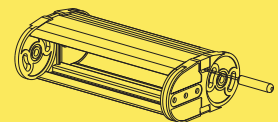

How to open the cover.

For further information please consult Brevetti Stendalto's Technical Office